



FECHADURAS E CADEADOS





ÍNDICE

- 04 ■ LINHA ROLETE
- 09 ■ LINHA DESIGN . SÉRIE 8000
- 12 ■ LINHA DESIGN . SÉRIE 7000
- 18 ■ LINHA SELF . SÉRIE 7000
- 21 ■ LINHA FASHION . SÉRIE 7000
- 24 ■ LINHA COLONIAL . SÉRIE 7000
- 25 ■ PERFIS . SÉRIE 6000
- 27 ■ PERFIS . SÉRIE 5000
- 31 ■ FECHADURA RESIDENCIAL . SÉRIE 4000
- 34 ■ FECHADURAS PARA PORTAS OU JANELAS DE VIDRO . SÉRIE 3000
- 36 ■ FECHADURAS DE SOBREPOR . SÉRIE 1000
- 37 ■ MAÇANETAS DE REPOSIÇÃO
- 39 ■ CILINDROS DE REPOSIÇÃO
- 40 ■ CADEADOS
- 41 ■ MÓVEIS
- 43 ■ FERRAGENS



FECHADURAS E CADEADOS

LINHA ROLETE SÉRIE 8000

Fechadura Residencial Trinco Rolete
 Porta Pivotante

SÉRIE 7000



Chapa-testa e contra-testa com canto RETO ou ARREDONDADO

ROSETA INOX



820R06 840R06

ROSETA ZAMAC



821R06 841R06 835R06



REGULAGEM DO ROLETE



TETRA

ROSETAS

Broca 55 - Cilindro Tetra Embutido

Atende a norma ABNT/NBR 14913

ESPESSURA MÁXIMA DA PORTA

CILINDRO	ROSETA ZAMAC	ROSETA INOX
06	50mm	55mm



Antique



Pintado Branco



Cromado



Preto Fosco



Latonado Oxidado

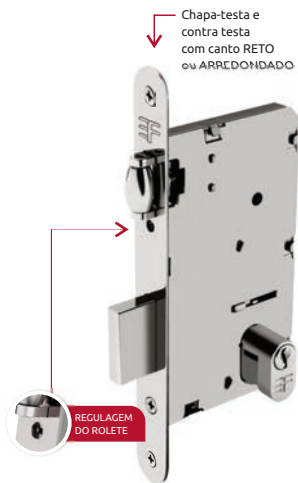

Chapa-testa e contra-testa com canto RETO ou ARREDONDADO

ROSETA INOX



820R55 840R55

ROSETA ZAMAC



821R55 841R55 835R55



REGULAGEM DO ROLETE



EXTERNA

ROSETAS

Broca 55

Cilindro Monobloco 60/74/90mm

Atende a norma ABNT/NBR 14913

ESPESSURA MÁXIMA DA PORTA

CILINDRO	ROSETA ZAMAC	ROSETA INOX
60mm	35mm	40mm
74mm	50mm	55mm
90mm	65mm	70mm



Antique



Pintado Branco



Cromado



Preto Fosco



Latonado Oxidado



Chapa-testa e contra-testa com canto RETO ou ARREDONDADO

ROSETA INOX



720R55 740R55

ROSETA ZAMAC



721R55 741R55 735R55



REGULAGEM DO ROLETE



EXTERNA

ROSETAS

Broca 40

Cilindro Monobloco 55/74/90mm

Atende a norma ABNT/NBR 14913

ESPESSURA MÁXIMA DA PORTA

CILINDRO	ROSETA ZAMAC	ROSETA INOX
55mm	35mm	35mm
74mm	55mm	55mm
90mm	70mm	70mm



Antique



Pintado Branco



Cromado



Preto Fosco



Latonado Oxidado

ROSETA INOX



Espessura: 6mm

ROSETA ZAMAC



Espessura: 8,5mm

LINHA ROLETE SÉRIE 5000

Fechadura Residencial Trinco Rolete
 Porta Pivotante

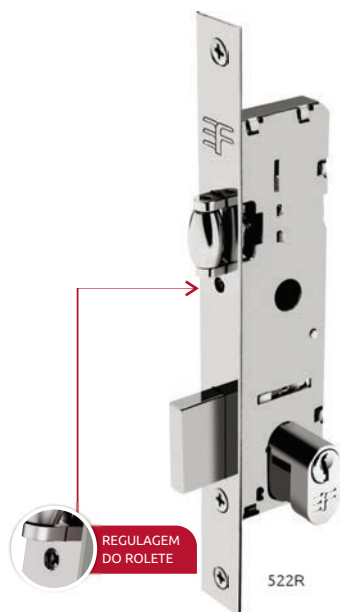

! ATENDE TUBO/METALON DE FERRO OU PERFIL DE ALUMÍNIO 40 X 30
 Também atende perfis búzios com os cilindros 3F de 74mm ou 90mm

ESPELHOS OBLONGOS

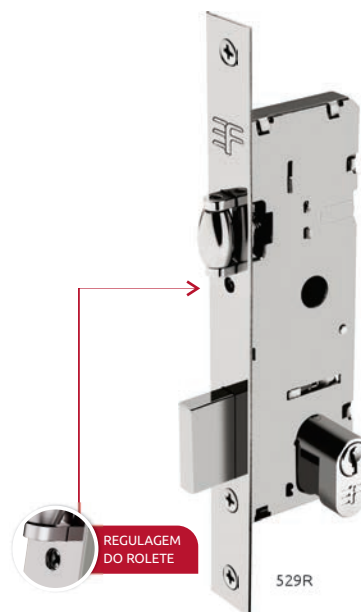

! ATENDE TUBO/METALON DE FERRO OU PERFIL DE ALUMÍNIO 50 X 30
 Também atende perfis búzios com os cilindros 3F de 74mm ou 90mm

ESPELHOS OBLONGOS



EXTERNA

ESPELHO OBLONGO
Broca 21 - Cilindro 50/74/90mm
 Atende a norma ABNT/NBR 14913

ESPESSURA MÁXIMA DA PORTA

CILINDRO	ESPELHO OBLONGO PLANO	ESPELHO OBLONGO DESIGN
50mm	40mm	30mm
74mm	65mm	55mm
90mm	80mm	70mm

Cromado Pintado Branco Pintado Preto



EXTERNA

ESPELHO OBLONGO
Broca 28 - Cilindro 50/74/90mm
 Atende a norma ABNT/NBR 14913

ESPESSURA MÁXIMA DA PORTA

CILINDRO	ESPELHO OBLONGO PLANO	ESPELHO OBLONGO DESIGN
50mm	40mm	30mm
74mm	65mm	55mm
90mm	80mm	70mm

Cromado Pintado Branco Pintado Preto

LINHA ROLETE SÉRIE 4000

Fechadura Residencial Trinco Rolete
 Porta Pivotante



4145R

! Disponível também na opção PAR

ROSETA INOX



4145R55/CR 4145R55/CR-Q
 4345R/CR 4345R/CR-Q

ROSETA ZAMAC



4145R55/ZCR 4145R55/ZCR-Q 4145R55/ZCR-D
 4345R/ZCR 4345R/ZCR-Q 4345R/ZCR-D



EXTERNA BANHEIRO

ROSETAS

Broca 45 - Cilindro 60/74/90mm
 Atende a norma ABNT/NBR 14913

ESPESSURA MÁXIMA DA PORTA

CILINDRO	ROSETA ZAMAC	ROSETA INOX
60mm	35mm	40mm
74mm	50mm	55mm
90mm	65mm	70mm

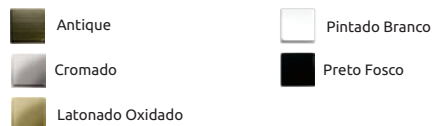

FECHO ROLETE



REFERÊNCIA | DESCRIÇÃO

265 | Rolete



REGULAGEM DO ROLETE

KIT ROLETE SÉRIE 8000

Fechadura Residencial Trinco Rolete
 Porta Pivotante

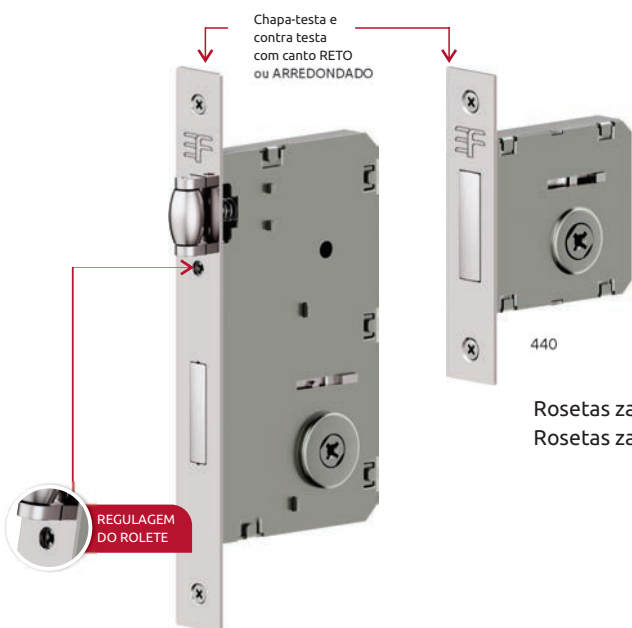

ROSETA INOX



ROSETA ZAMAC



Rosetas zamac da fechadura principal - 56mm
 Rosetas zamac da fechadura auxiliar - 50mm

ROSETAS
Broca 55 - Cilindro Tetra Embutido
 TETRA Atende a norma ABNT/NBR 14913

ESPESSURA MÁXIMA DA PORTA

CILINDRO	ROSETA ZAMAC	ROSETA INOX
06	50mm	55mm



O kit pode acompanhar até 2 fechaduras auxiliares

Abertura de todas as fechaduras do kit com **UMA ÚNICA CHAVE!**

SÉRIE 7000

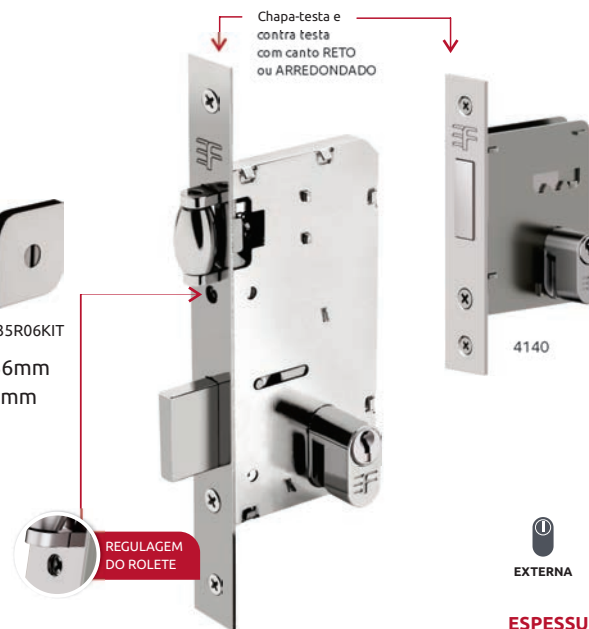

ROSETA INOX



ROSETA ZAMAC



ROSETAS
Broca 40
Cilindro Monobloco 55/74/90mm
 EXTERNA Atende a norma ABNT/NBR 14913

ESPESSURA MÁXIMA DA PORTA

CILINDRO	ROSETA ZAMAC	ROSETA INOX
55mm	35mm	35mm
74mm	55mm	55mm
90mm	70mm	70mm

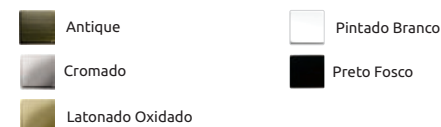

O kit pode acompanhar até 2 fechaduras auxiliares

Abertura de todas as fechaduras do kit com **UMA ÚNICA CHAVE!**

KIT ROLETE SÉRIE 5000

Fechadura Residencial Trinco Rolete Porta Pivotante

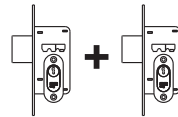

- ! O kit pode acompanhar até 2 fechaduras auxiliares
- ! Abertura de todas as fechaduras do kit com **UMA ÚNICA CHAVE!**
- ! **ATENDE TUBO/METALON DE FERRO OU PERFIL DE ALUMÍNIO 40 X 30**
Também atende perfis búzios com os cilindros 3F de 74mm ou 90mm

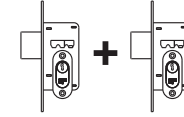

- ! O kit pode acompanhar até 2 fechaduras auxiliares
- ! Abertura de todas as fechaduras do kit com **UMA ÚNICA CHAVE!**
- ! **ATENDE TUBO/METALON DE FERRO OU PERFIL DE ALUMÍNIO 50 X 30**
Também atende perfis búzios com os cilindros 3F de 74mm ou 90mm

REGULAGEM DO ROLETE

REGULAGEM DO ROLETE



EXTERNA



EXTERNA

ESPELHO OBLONGO
Broca 21 - Cilindro 50/74/90mm
Atende a norma ABNT/NBR 14913

ESPELHO OBLONGO
Broca 28 - Cilindro 50/74/90mm
Atende a norma ABNT/NBR 14913

ESPESSURA MÁXIMA DA PORTA

CILINDRO	ESPELHO OBLONGO PLANO	ESPELHO OBLONGO DESIGN
50mm	40mm	30mm
74mm	65mm	55mm
90mm	80mm	70mm

ESPESSURA MÁXIMA DA PORTA

CILINDRO	ESPELHO OBLONGO PLANO	ESPELHO OBLONGO DESIGN
50mm	40mm	30mm
74mm	65mm	55mm
90mm	80mm	70mm

ESPELHOS OBLONGOS



Design Plano



Cromado

Pintado Branco



Pintado Preto

ESPELHOS OBLONGOS



Design Plano



Cromado

Pintado Branco



Pintado Preto

LINHA DESIGN . SÉRIE 8000

ESPELHO GRAZIA

Fechadura Residencial
 Porta de Bater



Broca 55 - Cilindro Monobloco 60/74/90mm

Atende a norma ABNT/NBR 14913

CILINDRO	ESPESSURA MÁXIMA DA PORTA
06	45mm
60mm	40mm
74mm	55mm
90mm	70mm



813E812

813E813

813E817

813E819

ROSETA REDONDA



Broca 55 - Cilindro Monobloco 60/74/90mm

Atende a norma ABNT/NBR 14913

CILINDRO	ROSETA ZAMAC	ROSETA INOX
06	40mm	45mm
60mm	35mm	40mm
74mm	50mm	55mm
90mm	65mm	70mm



ROSETA INOX 820E812
 ROSETA ZAMAC 821E812

*ROSETA INOX 820E813
 ROSETA ZAMAC 821E813

ROSETA INOX 820E817
 ROSETA ZAMAC 821E817

ROSETA INOX 820E819
 ROSETA ZAMAC 821E819

ROSETA INOX

ROSETA ZAMAC

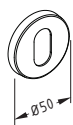

Espessura: 6mm

Espessura: 8,5mm

LINHA DESIGN . SÉRIE 8000

ROSETA QUADRADA



ROSETA INOX 840E812
ROSETA ZAMAC 841E812

ROSETA INOX 840E813
ROSETA ZAMAC 841E813

ROSETA INOX 840E817
ROSETA ZAMAC 841E817

ROSETA INOX 840E819
ROSETA ZAMAC 841E819

ROSETA INOX

ROSETA ZAMAC

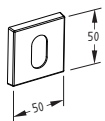

Espessura: 6mm

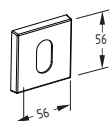

Espessura: 8,5mm

ROSETA DESIGN



ROSETA ZAMAC 835E812

ROSETA ZAMAC 835E813

ROSETA ZAMAC 835E817

ROSETA ZAMAC 835E819

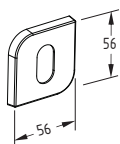

Espessura: 8,5mm



Fechadura Residencial
Porta de Bater



TETRA EXTERNA INTERNA BANHEIRO

Broca 55 - Cilindro Monobloco 60/74/90mm
Atende a norma ABNT/NBR 14913

ESPESSURA MÁXIMA DA PORTA

CILINDRO	ROSETA ZAMAC	ROSETA INOX
06	40mm	45mm
60mm	35mm	40mm
74mm	50mm	55mm
90mm	65mm	70mm

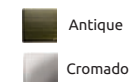

Antique

Cromado



Latonado Oxidado

Preto Fosco



TETRA EXTERNA INTERNA BANHEIRO

Broca 55 - Cilindro Monobloco 60/74/90mm
Atende a norma ABNT/NBR 14913

CILINDRO | **ESPESSURA MÁXIMA DA PORTA**

CILINDRO	ESPESSURA MÁXIMA DA PORTA
06	40mm
60mm	35mm
74mm	50mm
90mm	65mm

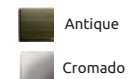

Antique

Cromado

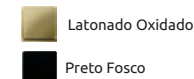

Latonado Oxidado

Preto Fosco

KIT TETRA . SÉRIE 8000



Fechadura Residencial
 Porta de Bater



813T812KIT3

ROSETA INOX 820T813KIT3
 ROSETA ZAMAC 821T813KIT3

ROSETA INOX 840T817KIT3
 ROSETA ZAMAC 841T817KIT3

ROSETA ZAMAC 835T819KIT3

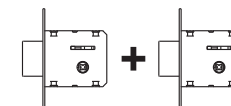

- ! O kit pode acompanhar até 2 fechaduras auxiliares
- ! Abertura de todas as fechaduras do kit com UMA ÚNICA CHAVE!
- ! Chapa-testa e contra testa com canto RETO ou ARREDONDADO

Rosetas zamac da fechadura principal - 56mm
 Rosetas zamac da fechadura auxiliar - 50mm

ROSETA INOX

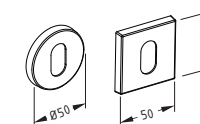

Espessura: 6mm

ROSETA ZAMAC

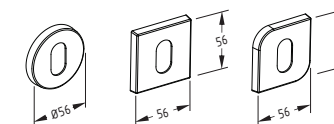

Espessura: 8,5mm

- Antique
- Cromado
- Latonado Oxidado
- Preto Fosco



TETRA

Broca 55 - Cilindro Tetra Embutido

Atende as normas ABNT/NBR 13060 e 14913

ESPESSURA MÁXIMA DA PORTA

CILINDRO	ROSETA ZAMAC	ROSETA E ESPELHO INOX
06	40mm	45mm

LINHA DESIGN . SÉRIE 7000

ESPELHO BELLA



Fechadura Residencial
 Porta de Bater



733E113



733E116



733E117



733E119



733E127



733E128



733E773



733E334



Broca 40 - Cilindro Monobloco 55/74/90mm
 Atende a norma ABNT/NBR 14913

CILINDRO	ESPESSURA MÁXIMA DA PORTA
06	40mm
55mm	35mm
74mm	55mm
90mm	70mm

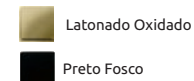
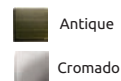

LINHA DESIGN . SÉRIE 7000

ESPELHO GRAZIA



Fechadura Residencial
 Porta de Bater



713E113



713E116



713E117



713E119



713E127



713E128



713E773



713E334



Broca 40 - Cilindro Monobloco 55/74/90mm

Atende a norma ABNT/NBR 14913

CILINDRO	ESPESSURA MÁXIMA DA PORTA
06	40mm
55mm	35mm
74mm	55mm
90mm	70mm

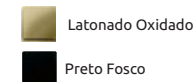
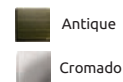

LINHA DESIGN . SÉRIE 7000

ROSETA REDONDA



Fechadura Residencial
 Porta de Bater



ROSETA INOX 720E113
 ROSETA ZAMAC 721E113



ROSETA INOX 720E116
 ROSETA ZAMAC 721E116



ROSETA INOX 720E117
 ROSETA ZAMAC 721E117



ROSETA INOX 720E119
 ROSETA ZAMAC 721E119



ROSETA INOX 720E127
 ROSETA ZAMAC 721E127



ROSETA INOX 720E128
 ROSETA ZAMAC 721E128



ROSETA INOX 720E773
 ROSETA ZAMAC 721E773



ROSETA INOX 720E334
 ROSETA ZAMAC 721E334



Espessura: 6mm



TETRA



EXTERNA



INTERNA



BANHEIRO

Broca 40 - Cilindro Monobloco 55/74/90mm

Atende a norma ABNT/NBR 14913

CILINDRO	ESPESSURA MÁXIMA DA PORTA
06	40mm
55mm	35mm
74mm	55mm
90mm	70mm



Antique



Latonado Oxidado



Cromado



Preto Fosco

LINHA DESIGN . SÉRIE 7000

ROSETA QUADRADA



Fechadura Residencial
 Porta de Bater



ROSETA INOX 740E113
 ROSETA ZAMAC 741E113



ROSETA INOX 740E116
 ROSETA ZAMAC 741E116



ROSETA INOX 740E117
 ROSETA ZAMAC 741E117



ROSETA INOX 740E119
 ROSETA ZAMAC 741E119



ROSETA INOX 740E127
 ROSETA ZAMAC 741E127



ROSETA INOX 740E128
 ROSETA ZAMAC 741E128



ROSETA INOX 740E773
 ROSETA ZAMAC 741E773



ROSETA INOX 740E334
 ROSETA ZAMAC 741E334

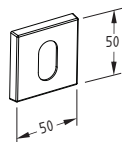

Espessura: 6mm



Broca 40 - Cilindro Monobloco 55/74/90mm
 Atende a norma ABNT/NBR 14913

CILINDRO	ESPESSURA MÁXIMA DA PORTA
06	40mm
55mm	35mm
74mm	55mm
90mm	70mm

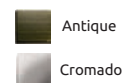

Antique

Cromado

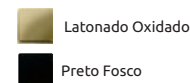

Latonado Oxidado

Preto Fosco

LINHA DESIGN . SÉRIE 7000

ROSETA DESIGN



Fechadura Residencial
 Porta de Bater



ROSETA ZAMAC 735E113



ROSETA ZAMAC 735E116



ROSETA ZAMAC 735E117



ROSETA ZAMAC 735E119



ROSETA ZAMAC 735E127



ROSETA ZAMAC 735E128



ROSETA ZAMAC 735E773



ROSETA ZAMAC 735E334

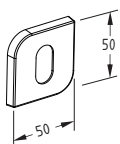

Espessura: 6mm



TETRA EXTERNA INTERNA BANHEIRO

Broca 40 - Cilindro Monobloco 55/74/90mm

Atende a norma ABNT/NBR 14913

CILINDRO	ESPESSURA MÁXIMA DA PORTA
06	40mm
55mm	35mm
74mm	55mm
90mm	70mm

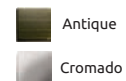

Antique

Cromado

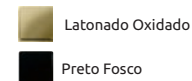

Latonado Oxidado

Preto Fosco

KIT TETRA . SÉRIE 7000



Fechadura Residencial
Porta de Bater

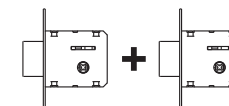

- ! O kit pode acompanhar até 2 fechaduras auxiliares
- ! Abertura de todas as fechaduras do kit com UMA ÚNICA CHAVE!
- ! Chapa-testa e contra testa com canto RETO ou ARREDONDADO



733T127KIT3

713T128KIT3

ROSETA INOX 720T116KIT3
ROSETA ZAMAC 721T116KIT3

ROSETA INOX 740T117KIT3
ROSETA ZAMAC 741T117KIT3

ROSETA ZAMAC 735T119KIT3

Broca 40 - Cilindro Tetra Embutido
Atende as normas ABNT/NBR 13060 e 14913

ROSETA INOX

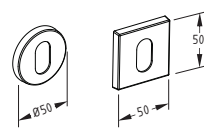

Espessura: 6mm

ROSETA ZAMAC

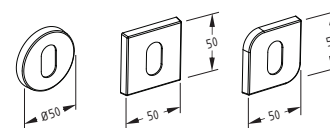

Espessura: 6mm

ESPESSURA MÁXIMA DA PORTA: 40mm



LINHA SELF . SÉRIE 7000

ESPELHO PLENNUS 40



710E113

710E116

710E117



710E119



710E220



710E334



Fechadura Residencial
Porta de Bater

ESPELHO STILLUS 40



711E113

711E116

711E117



711E119



711E220



711E334



Broca 40 - Cilindro Monobloco 55mm
Atende a norma ABNT/NBR 14913

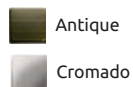

ESPESSURA MÁXIMA DA PORTA: 35mm



Broca 40 - Cilindro Monobloco 55mm
Atende a norma ABNT/NBR 14913

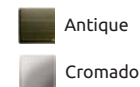

ESPESSURA MÁXIMA DA PORTA: 35mm

LINHA SELF . SÉRIE 7000

ESPELHO BELLA 40



Fechadura Residencial
 Porta de Bater



712E113



712E116



712E117



712E119



712E220



712E334



Broca 40 - Cilindro Monobloco 55mm
 Atende a norma ABNT/NBR 14913

ESPESSURA MÁXIMA DA PORTA: 35mm

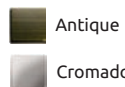

KIT TETRA . SÉRIE 7000



Fechadura Residencial
 Porta de Bater



710T113KIT3



711T334KIT3



712T117KIT3

ROSETA INOX

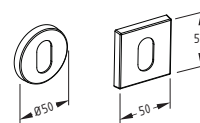

Espessura: 6mm



TETRA

Broca 40 - Cilindro Tetra Embutido

Atende a norma ABNT/NBR 14913

ESPESSURA MÁXIMA DA PORTA: 35mm

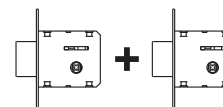
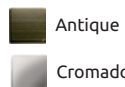

! O kit pode acompanhar até 2 fechaduras auxiliares

! Abertura de todas as fechaduras do kit com **UMA ÚNICA CHAVE!**

! Chapa-testa e contra testa com canto **RETO** ou **ARREDONDADO**

LINHA FASHION . SÉRIE 7000



Fechadura Residencial
Porta de Bater

ESPELHO PLENNUS 36



716E112

716E123

716E124

ESPELHO BELLA 36



732E112

732E123

732E124



716E220

716E330



732E220

732E330



EXTERNA INTERNA BANHEIRO

Broca 40 - Cilindro Monobloco 50mm

Atende a norma ABNT/NBR 14913

Antique

Pintado Branco

ESPESSURA MÁXIMA DA PORTA: 35mm

Cromado

Pintado Preto



EXTERNA INTERNA BANHEIRO

Broca 40 - Cilindro Monobloco 50mm

Atende a norma ABNT/NBR 14913

Antique

Pintado Branco

ESPESSURA MÁXIMA DA PORTA: 35mm

Cromado

Pintado Preto

LINHA FASHION . SÉRIE 7000



Fechadura Residencial
 Porta de Bater

ESPELHO STILLUS 36



718E112



718E123



718E124



718E220



718E330



EXTERNA



INTERNA



BANHEIRO

Broca 40 - Cilindro Monobloco 50mm

Atende a norma ABNT/NBR 14913



Antique



Cromado



Pintado Branco



Pintado Preto

ESPESSURA MÁXIMA DA PORTA: 35mm

LINHA FASHION . SÉRIE 7000



Fechadura Residencial
Porta de Bater

ROSETA REDONDA



722E112



722E123



722E124



722E220



722E330



Espessura: 6mm



Broca 40 - Cilindro Monobloco 50mm
Atende a norma ABNT/NBR 14913

ESPESSURA MÁXIMA DA PORTA: 35mm



ROSETA QUADRADA



742E112



742E123



742E124



742E220



742E330

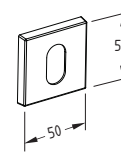

Espessura: 6mm



Broca 40 - Cilindro Monobloco 50mm
Atende a norma ABNT/NBR 14913

ESPESSURA MÁXIMA DA PORTA: 35mm



LINHA COLONIAL . SÉRIE 7000



Fechadura Residencial
 Porta de Bater

ESPELHO



715E115



715E225

- TETRA
- EXTERNA
- INTERNA
- BANHEIRO

Broca 40 - Cilindro Monobloco 55mm

Atende a norma ABNT/NBR 14913

ESPESSURA MÁXIMA DA PORTA: 30mm

Latonado Oxidado

ROSETA



725E115



725E225

- EXTERNA
- INTERNA
- BANHEIRO

Broca 40 - Cilindro Monobloco 55mm

Atende a norma ABNT/NBR 14913

ESPESSURA MÁXIMA DA PORTA: 30mm

Latonado Oxidado

PERFIS . SÉRIE 6000

Portas e Janelas de Correr



! ATENDE PERFIL "SUPREMA", ATUAL "LINHA INOVA"
Também atende perfis búzios com os cilindros 3F de 74mm ou 90mm

6115-S
6515-S



! ATENDE ATUAL "LINHA GOLD"
Também atende perfis búzios com os cilindros 3F de 74mm ou 90mm

6115
6515



! ATENDE TUBO/METALON DE FERRO OU PERFIL DE ALUMÍNIO 30 X 30
Também atende perfis búzios com os cilindros 3F de 74mm ou 90mm

615
655

ESPELHOS OBLONGOS



Design Plano



EXTERNA

Cilindro 1/2/50/74/90mm
Espelho Oblongo
Bico de Papagaio - Broca 15mm / 19mm
Atende a norma ABNT/NBR 13053

ESPESSURA MÁXIMA DA PORTA

CILINDRO	ESPELHO OBLONGO PLANO	ESPELHO OBLONGO CONVENCIONAL
1/2	40mm	30mm
50mm	40mm	30mm
74mm	65mm	55mm
90mm	80mm	70mm



! ATENDE TUBO/METALON DE FERRO OU PERFIL DE ALUMÍNIO 40 X 30
Também atende perfis búzios com os cilindros 3F de 74mm ou 90mm



EXTERNA

Cilindro 1/2/50/74/90mm
Espelho Oblongo
Bico de Papagaio - Broca 22mm
Atende a norma ABNT/NBR 13053

6122
6522

ESPESSURA MÁXIMA DA PORTA

CILINDRO	ESPELHO OBLONGO PLANO	ESPELHO OBLONGO DESIGN
1/2	40mm	30mm
50mm	40mm	30mm
74mm	65mm	55mm
90mm	80mm	70mm



ESPELHOS OBLONGOS



Design Plano

PERFIS . SÉRIE 6000

Portas e Janelas de Correr



! ATENDE TUBO/METALON DE FERRO OU PERFIL DE ALUMÍNIO 50 X 30
Também atende perfis búzios com os cilindros 3F de 74mm ou 90mm

6129
6529



! ATENDE TUBO/METALON DE FERRO OU PERFIL DE ALUMÍNIO 40 X 30
Também atende perfis búzios com os cilindros 3F de 74mm ou 90mm

629
659

ESPELHOS OBLONGOS



Design Plano



EXTERNA

Cilindro 1/2/50/74/90mm
Espelho Oblongo
Bico de Papagaio - Broca 28mm / 29mm
Atende a norma ABNT/NBR 13053

ESPESSURA MÁXIMA DA PORTA

CILINDRO	ESPELHO OBLONGO PLANO	ESPELHO OBLONGO DESIGN
1/2	40mm	30mm
50mm	40mm	30mm
74mm	65mm	55mm
90mm	80mm	70mm



6145
6545

ROSETA INOX



6145/50CR 6145/50CR-Q

ROSETA ZAMAC



6145/50ZCR 6145/50ZCR-Q 6145/50ZCR-D



EXTERNA INTERNA

Cilindro 1/2/50/74/90mm
Roseta ou Concha
Bico de Papagaio - Broca 45mm
Atende a norma ABNT/NBR 13053



CONCHA



CILINDRO	ESPESSURA MÁXIMA DA PORTA
1/2	30mm
50mm	30mm
74mm	55mm
90mm	70mm



6445

! Conchas indisponíveis no acabamento AT

PERFIS . SÉRIE 5000

Portas de Bater



← Perfil
MAIS ESTREITO
do mercado

511

GUARNIÇÕES



511/112



511/124

! ATENDE TUBO/METALON DE FERRO
OU PERFIL DE ALUMÍNIO 25 X 25

Também atende perfis búzios com
os cilindros 3F de 74mm ou 90mm



EXTERNA Broca 11 - Cilindro Bi-Partido 60/74/90mm

ESPESSURA MÁXIMA DA PORTA

CILINDRO	ESPESSURA
60mm	45mm
74mm	65mm
90mm	80mm

 Cromado

 Pintado Branco

 Pintado Preto

PERFIS . SÉRIE 5000

GUARNIÇÕES



522



522B



529

! ATENDE TUBO/METALON DE FERRO OU PERFIL DE ALUMÍNIO 40 X 30
Também atende perfis búzios com os cilindros 3F de 74mm ou 90mm

! ATENDE TUBO/METALON DE FERRO OU PERFIL DE ALUMÍNIO 50 X 30
Também atende perfis búzios com os cilindros 3F de 74mm ou 90mm



522/112
529/112



522/116
529/116



522/119
529/119



522/124
529/124



522/127
529/127



522/220
529/220



522/330
529/330



Broca 21/28 - Cilindro 50/74/90mm
Atende a norma ABNT/NBR 14913

ESPESSURA MÁXIMA DA PORTA

CILINDRO	ESPELHO PLANO	ESPELHO CONVENCIONAL
50mm	40mm	35mm
74mm	65mm	60mm
90mm	80mm	75mm

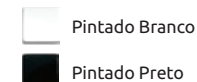
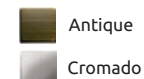

PERFIS . SÉRIE 5000

Portas de Bater

GUARNIÇÕES



5122

! ATENDE TUBO/METALON DE FERRO OU PERFIL DE ALUMÍNIO 40 X 30 Também atende perfis búzios com os cilindros 3F de 74mm ou 90mm



5129

! ATENDE TUBO/METALON DE FERRO OU PERFIL DE ALUMÍNIO 50 X 30 Também atende perfis búzios com os cilindros 3F de 74mm ou 90mm



5122/116
5129/116



5122/119
5129/119



5122/123
5129/123



5122/127
5129/127



5122/334
5129/334



Broca 21/28 - Cilindro 50/74/90mm
Atende a norma ABNT/NBR 14913

ESPESSURA MÁXIMA DA PORTA

CILINDRO	ESPELHO PLANO	ESPELHO CONVENCIONAL
50mm	40mm	35mm
74mm	65mm	60mm
90mm	80mm	75mm

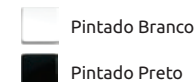
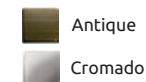

KIT PERFIS . SÉRIE 5000

Portas de Bater



522/112K3ED

! ATENDE TUBO/METALON DE FERRO OU PERFIL DE ALUMÍNIO 40 X 30
Também atende perfis búzios com os cilindros 3F de 74mm ou 90mm



529/112K3ED

! ATENDE TUBO/METALON DE FERRO OU PERFIL DE ALUMÍNIO 50 X 30
Também atende perfis búzios com os cilindros 3F de 74mm ou 90mm

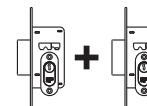

- !** O kit pode acompanhar até 2 fechaduras auxiliares
- !** Abertura de todas as fechaduras do kit com **UMA SÓ CHAVE!**



Broca 21 e 28 - Cilindro 50/74/90mm
Atende a norma ABNT/NBR 14913

CILINDRO	ESPELHO OBLONGO PLANO	ESPELHO OBLONGO DESIGN
50mm	40mm	30mm
74mm	65mm	55mm
90mm	80mm	70mm

- Cromado
- Pintado Branco
- Pintado Preto

FECHADURA RESIDENCIAL . SÉRIE 4000

Portas de Correr
Portas de Bater

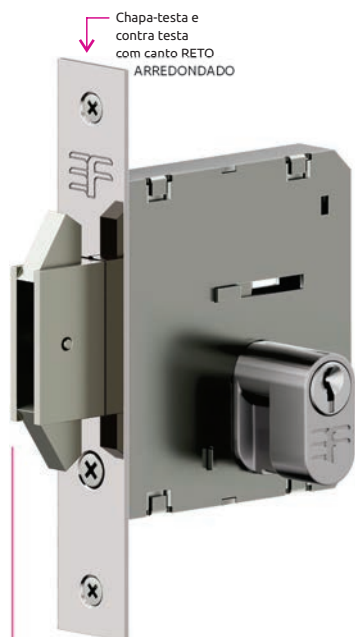

1ª VOLTA



2ª VOLTA

IMPORTANTE

A fechadura 4145BP possui lingueta com trava universal. Em portas de correr, a porta só será trancada após completar a 2ª volta da chave.

ROSETA INOX

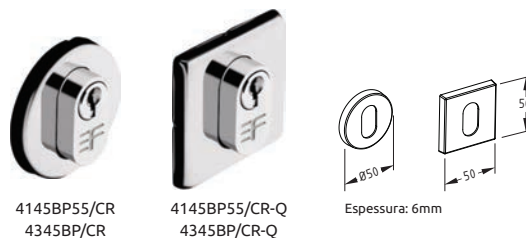

ROSETA ZAMAC



ROSETAS Broca 45 - Cilindro 60/74/90mm

ESPESSURA MÁXIMA DA PORTA

CILINDRO	ROSETA ZAMAC	ROSETA ESTAMPADA
60mm	35mm	40mm
74mm	50mm	55mm
90mm	65mm	70mm



AUXILIARES . SÉRIE 4000

Portas de Bater



← Chapa-testa e contra testa com canto RETO ou ARREDONDADO

! ATENDE TUBO/METALON DE FERRO OU PERFIL DE ALUMÍNIO 40 X 30
Também atende perfis búzios com os cilindros 3F de 74mm ou 90mm

4122
4522



← Chapa-testa e contra testa com canto RETO ou ARREDONDADO

! ATENDE TUBO/METALON DE FERRO OU PERFIL DE ALUMÍNIO 40 X 30

! 2 ou 4 chaves de latão

Fechadura vendida em cartela ou caixa individual.

422



← Chapa-testa e contra testa com canto RETO ou ARREDONDADO

! ATENDE TUBO/METALON DE FERRO OU PERFIL DE ALUMÍNIO 50 X 30
Também atende perfis búzios com os cilindros 3F de 74mm ou 90mm

4129
4529



← Chapa-testa e contra testa com canto RETO ou ARREDONDADO

! ATENDE TUBO/METALON DE FERRO OU PERFIL DE ALUMÍNIO 50 X 30

! 2 ou 4 chaves de latão

Fechadura vendida em cartela ou caixa individual.

430



← Chapa-testa e contra testa com canto RETO ou ARREDONDADO

! ATENDE TUBO/METALON DE FERRO OU PERFIL DE ALUMÍNIO 50 X 30

! 2 ou 4 chaves de latão

Fechadura vendida em cartela ou caixa individual.

430BP



Broca 22 / 29 / 30mm - Espelho Oblongo
Trava de Segurança - Cilindro 06/½/50/74/90mm
Atende a norma ABNT/NBR 13060

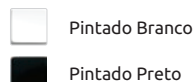
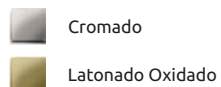

! Todos os modelos desta página disponíveis também na opção par

ESPESSURA MÁXIMA DA PORTA

CILINDRO	ESPELHO OBLONGO PLANO	ESPELHO OBLONGO DESIGN
06	40mm	55mm
½	40mm	35mm
50mm	40mm	30mm
74mm	65mm	55mm
90mm	80mm	70mm

ESPELHOS OBLONGOS



AUXILIARES . SÉRIE 4000

Portas de Bater



4140
4540

Chapa-testa e
contra testa
com canto RETO
ou ARREDONDADO

ROSETA INOX



4140/50CR

4140/50CR-Q

ROSETA ZAMAC



4140/50ZCR

4140/50ZCR-Q

4140/50ZCR-D



! 2 ou 4 chaves de latão

Fechadura vendida em cartela
ou caixa individual.

440

Chapa-testa e
contra testa
com canto RETO
ou ARREDONDADO

ROSETA INOX



440CR

440CR-Q

ROSETA ZAMAC



440ZCR

440ZCR-Q

440ZCR-D

! Todos os modelos desta página
disponíveis também na opção par



Broca 40mm - Roseta
Trava de Segurança - Cilindro 06/½/50/74/90mm
Atende a norma ABNT/NBR 13060



CILINDRO	ESPESSURA MÁXIMA DA PORTA
06	55mm
½	35mm
50mm	30mm
74mm	55mm
90mm	70mm

FECHADURA PARA PORTA OU JANELA DE VIDRO TEMPERADO . SÉRIE 3000



3030
3530



3031
3531

! **3F 3030/3031:** para instalação 3210
3F 3530/3531: para instalação 3212



EXTERNA EXTERNA

Furação Blindex

Atende a norma ABNT/NBR 14651

Cromado Pintado Preto



3040
3540



3041
3541

! **3F 3050:** para instalação 3530 ou 1510X
3F 3550: para instalação 3532



EXTERNA EXTERNA

Recorte Santa Marina

Atende a norma ABNT/NBR 14651

Cromado Pintado Preto



3050
3550



3051
3551

! **3F 3040/3041:** para instalação 1520
3F 3540/3541: para instalação 1520 ½ Cilindro



EXTERNA EXTERNA

Furação Blindex

Atende a norma ABNT/NBR 14651

Cromado Pintado Preto

Mini Fechadura

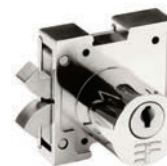

3061



EXTERNA

Atende a norma ABNT/NBR 14651

Cromado Pintado Preto

FECHADURA PARA VITRINE . SÉRIE 3000



3011

Cromado

Pintado Preto

FECHADURA COM MAÇANETA PARA PORTA DE VIDRO TEMPERADO . SÉRIE 3000



3080



3090

MAÇANETAS DE REPOSIÇÃO:



112V



116V



119V



124V



334V



EXTERNA

Broca 21/25 - Cilindro 60mm
Recorte Santa Marina



Cromado



Pintado Preto



Pintado Branco

! O produto possui **testa inox**, cilindro e maçanetas com acabamentos em CR, BR e PP.

REFERÊNCIA	DESCRIÇÃO	ACABAMENTOS
112V	Maçaneta Alavanca	CR BR PP
116V	Maçaneta Alavanca	CR BR PP
119V	Maçaneta Alavanca	CR BR PP
124V	Maçaneta Alavanca	CR BR PP
334V	Maçaneta Taco de Golfe	CR BR PP

FECHADURA DE SOBREPOR . SÉRIE 1000

FECHADURA PARA PORTÃO



1130



1130TETRA

! 2 ou 4 chaves de latão



TETRA EXTERNA

Atende a norma ABNT/NBR 13051

CAIXA E CASTANHA

- Inox
- Pintado Branco
- Pintado Preto

CILINDRO

- Niquelado

TRAVA CENTRAL PARA PORTA DE ENROLAR



1112TETRA

! 2 ou 4 chaves de latão

! Fornecida com os parafusos para fixação



TETRA

Pintado Preto

FECHADURA TIPO CAIXÃO



1220

INTERNA

Pintado Preto

Atende a norma ABNT/NBR 13049

MAÇANETAS DE REPOSIÇÃO

LINHA MARCENEIRO E SERRALHEIRO

! Os acabamentos das maçanetas de reposição seguem os padrões conforme apresentado nas linhas das fechaduras.



112



113



115



116



117



119



123



124



127



128



220



225

MAÇANETAS DE REPOSIÇÃO

LINHA MARCENEIRO E SERRALHEIRO

! Os acabamentos das maçanetas de reposição seguem os padrões conforme apresentado nas linhas das fechaduras.



330



334



773



812



813



817



819



55



65



68

CILINDROS DE REPOSIÇÃO

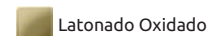

REF.	DESCRIÇÃO	UTILIZAÇÃO
000	Cilindro Reposição Fechaduras 3F - Comp. 55mm	4000 / 5000 / 6000 / 7000 - Oval Monobloco (13 x 27,5mm)
003	Cilindro Reposição Fechaduras 3F - Comp. 90mm	4000 / 5000 / 6000 / 7000 - Oval Monobloco (13 x 27,5mm)
005	½ Cilindro Reposição Fechaduras 3F	4000 / 6000 - Oval Monobloco (13 x 27,5mm)
006	Cilindro Reposição Fechaduras 3F Tetra / Reposição Fechadura PAPAIZ	4000 / 7000 / 8000 / 1112 Tetra 3F
007	Cilindro Reposição Fechaduras 3F - Comp. 74mm	4000 / 5000 / 6000 / 7000 - Oval Monobloco (13 x 27,5mm)
008	Cilindro Reposição Fechaduras 3F - Comp. 50mm	4000 / 5000 / 6000 / 7000 - Oval Monobloco (13 x 27,5mm)
010	Cilindro Reposição Fechadura ALIANÇA - Comp. 50mm	C 400 / C 700 - Oval Monobloco (14 x 26,8mm)
020	Cilindro Reposição Fechadura HAGA - Comp. 55mm	H1000/45 - H1000/55 - STD 40 - Oval Monobloco (15 x 27,5mm)
021	Cilindro Reposição Fechadura HAGA - Comp. 50mm	Modelo Berlin / Turim - Oval Monobloco (13 x 26mm)
025	Cilindro Reposição Fechadura MGM - Comp. 55mm	Stillo / Colonial - Oval Monobloco (15 x 27,5mm)
030	Cilindro Reposição Fechadura SOPRANO - Comp. 50mm	500 / 700 / 900 - Retangular Monobloco (14 x 27mm)
037	Cilindro Reposição Fechadura STAM - Comp. 74mm	500 / 600 / 800 / 900 - Oval Bipartido (14 x 28mm)
039	Cilindro Reposição Fechadura STAM - Comp. 90mm	500 / 600 / 800 / 900 - Oval Bipartido (14 x 28mm)
040	Cilindro Reposição Fechadura STAM - Comp. 60mm	500 / 600 / 800 / 900 - Oval Bipartido (14 x 28mm)
041	Cilindro Reposição Fechadura 3F - Comp. 60mm / Reposição Fechadura STAM	511 3F / Modelo 401 STAM - Oval Bipartido (14 x 28mm)
042	Cilindro Reposição Fechadura 3F - Comp. 74mm / Reposição Fechadura STAM	511 3F / Modelo 401 STAM - Oval Bipartido (14 x 28mm)
043	Cilindro Reposição Fechadura 3F - Comp. 90mm / Reposição Fechadura STAM	511 3F / Modelo 401 STAM - Oval Bipartido (14 x 28)
045	Cilindro Reposição Fechadura HELA - Comp. 60mm	2006 / 2010 - Oval Bipartido (14 x 28mm)
050	Cilindro Reposição Fechadura AROUCA - Comp. 55mm	2010/40 - Oval Monobloco (13 x 27,5mm)

REF.	DESCRIÇÃO	UTILIZAÇÃO
060	Cilindro Reposição Fechadura PADO - Comp. 50mm	460 - Retangular Monobloco (14 x 27mm) (Nariz 030 - Menor)
061	Cilindro Reposição Fechadura PADO - Comp. 50mm	725 - Retangular Monobloco (14 x 27mm) (Nariz 061 - Maior)
062	Cilindro Reposição Fechadura PADO - Comp. 55mm	735 / 835 - Retangular Monobloco (16 x 29mm)
063	Cilindro Reposição Fechadura PADO - Comp. 50mm	Concept - Oval Monobloco (13 x 27,5mm)
064	Cilindro Reposição Fechadura PADO - Comp. 55mm	Concept - Oval Monobloco (13 x 27,5mm)
065	½ Cilindro Reposição Fechadura PADO	Concept Bico de Papagaio - Oval Monobloco (13 x 27,5mm)
067	Cilindro Reposição Fechadura PADO - Comp. 74mm	Concept - Oval Monobloco (13 x 27,5mm)
069	Cilindro Reposição Fechadura PADO - Comp. 90mm	Concept - Oval Monobloco (13 x 27,5mm)
070	Cilindro Reposição Fechadura PAPAIZ - Comp. 55mm	C 400-55 - Oval Monobloco (13 x 27,5mm) (Nariz 3F - Menor)
071	Cilindro Reposição Fechadura PAPAIZ - Comp. 55mm	C 300-55 - Oval Monobloco (13 x 27,5mm) (Nariz P - Maior)
072	Cilindro Reposição Fechaduras 3F - Comp. 60mm / Reposição Fechadura PAPAIZ	4145 3F - 8000 3F / C 200-55 PAPAIZ - Oval Monobloco (15,5 x 30mm)
073	Cilindro Reposição Fechadura LaFonte - Comp. 60mm	Oval Monobloco (15 x 30mm)
074	Cilindro Reposição Fechaduras 3F - Comp. 74mm / Reposição Fechadura PAPAIZ	4145 3F - 8000 3F / C 200 PAPAIZ - Oval Monobloco (15,5 x 30mm)
080	Cilindro Reposição Fechadura IMAB - Comp. 55mm	3000 - Oval Monobloco (13 x 27,5mm)
090	Cilindro Reposição Fechaduras 3F - Comp. 90mm / Reposição Fechadura PAPAIZ	4145 3F - 8000 3F / C 200 PAPAIZ - Oval Monobloco (15,5 x 30mm)

CADEADOS

COM SEGREDO



CADEADO PARA MALA



CADEADO 25MM



CADEADO 40MM

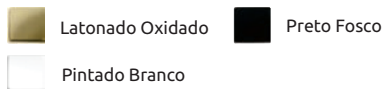

COM CHAVE



CADEADO P/ MALA

20MM

25MM

25MM - HASTE MÉDIA



30MM



30MM - HASTE MÉDIA



30MM - HASTE LONGA



35MM



35MM - HASTE LONGA



45MM

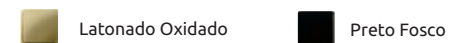

MÓVEIS

FECHADURA DE SOBREPOR



2210 A / 2210 C

REFERÊNCIA	DESCRIÇÃO	ACABAMENTOS
2210 A	Sobrepor com aba - Chave 3F	NB
2210 C	Sobrepor com aba - Chave Colonial	DV

FECHADURA COM CILINDRO DE PRESSÃO



2511 / 2512 / 2513

 Niquelado

FECHADURAS PARA GAVETA



2311
2312

 Niquelado

LINGUETAS



L04 / L06 / L08

 Zincado Branco

FECHOS



281

 Niquelado



282

CHAVES



AÇO



CABEÇA DE PLÁSTICO (CP)

 Inox



CABEÇA PLÁSTICA ARTICULADA (CPA)

 Inox

 Podemos fornecer a marca do cliente nas chaves de cabeça plástica (CP) e cabeça plástica articulada (CPA).

NOTA

Chaves fornecidas em pares.
Não são vendidas separadamente.

MÓVEIS

FECHADURA UNIVERSAL

Móveis de Aço



2711
2712
2741

Niquelado

Móveis de Madeira



2721
2722

FECHADURA PARA PAINÉIS

Fenda



2811

Niquelado

MAÇANETA COM TRAVA



2911

Niquelado

ACESSÓRIOS



822





824

REFERÊNCIA	DESCRIÇÃO	UTILIZAÇÃO	ACABAMENTOS
822ZNB	Chave 3F	2210 - A	NB
824ZOV	Chave Colonial	2210 - C	OV

FERRAGENS

FECHOS LIVRE/OCUPADO



-  Inox
-  Pintado Branco
-  Pintado Preto

262

! Espessura de porta:
Atende de 25mm até 50mm

FECHO BAULETE





264

 Niquelado

PUXADOR PARA JANELA



351

-  Niquelado
-  Zincado Branco



3f.com.br



FERRAGENS 3F DO BRASIL LTDA

Av. Gov. Roberto Silveira, 3110 - Conselheiro Paulino

Nova Friburgo - RJ

CEP: 28635-000 - Caixa Postal: 89770 - Tel/Fax: 22 2525-0030

CNPJ 02.464.189/0001-07

Indústria Brasileira



0800 022 0030

atendimento@3f.com.br